

- ATX 3.1 with PCIe GEN5
- 80PLUS® GOLD certified efficiency
- Japanese Main Capacitors
- LLC Half-Bridge converter with DC to DC technology
- Fully modular cable management

The CHIEFTEC Polaris 3.0 series is designed to Intel's ATX 3.1 standard and supports PCIe GEN 5 with 80 PLUS® GOLD certified efficiency, promising exceptional performance. Polaris 3.0 features state-of-the-art technical design including LLC half-bridge converter with DC-to-DC technology, as well as Japanese main capacitors to achieve low ripple and tight voltage regulation.

The Polaris 3.0 135mm FDB silent fan optimizes the balance between cooling and noise with excellent durability. Fully modular cable management ensures a clean and convenient build inside any system.







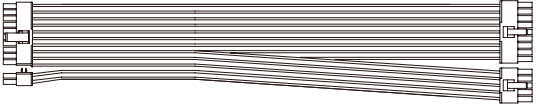

TECHNICAL DATA	
Model	Polaris 3.0 1050W
Articel no.	PPS-1050FC-A3
Specification	ATX 12V 3.1
Form factor	ATX
Efficiency	80 PLUS® GOLD
PFC	Active PFC (0.9)
Fan	135mm FDB fan
Dimension (DxWxH)	160mm x 150mm x 86mm
Security	AFC (Automatic Fan speed Control) OPP (Overload protection) OTP (Over Temperature Protection) OVP (Overvoltage protection) SCP (Short-circuit protection) SIP (Surge & Inrush Protection) UVP (Under Voltage protection) OCP (Over-Current Protection)
Warranty	5 Years

OUTPUT DATA						
PPS-1050FC-A3	AC Input	100-240V~ / 15-8A / 50 - 60Hz				
	DC Output	+3.3V	+5V	+12V	-12V	+5VSB
	Max. Current	22A	22A	87.5A	0.3A	3.0A
	Max. Combined Power	120W		1050W	3.6W	15W
			1050W			

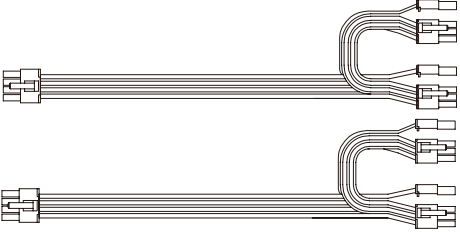
* The listed specifications may be altered at any point in time without any pre-notice.

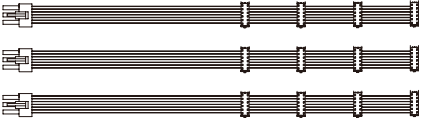
** Chieftec® is a registered trademark. All other brands and/or logos are property of the respective owners.

	Cable	Connectors	Length (mm)
	20+4 PIN ATX	1	650
	8 PIN EPS (4+4)	2	2 x 650
	8 PIN PCIe (6+2)	4	2 x 600/100
	16 PIN PCIe GEN5	1	600
	SATA	12	3 x 550/100/100/100
	MOLEX	4	550/100/100/100

Certification



Version: 01/2023

* The listed specifications may be altered at any point in time without any pre-notice.

** Chieftec® is a registered trademark. All other brands and/or logos are property of the respective owners.